

Wap

CATÁLOGO DE PEÇAS PARA REPOSIÇÃO



LAVADORA DE ALTA PRESSÃO WL 2660 TURBO / WL 2660 TURBO ULTRA

FW009595 (127V) ULTRA - FW009459 (127V)
FW009596 (220V) ULTRA - FW009460 (220V)

REVISÃO : 05 - MAIO/2025
REFERÊNCIA - VEG02.176

O conteúdo deste documento não deve ser reproduzido ou cedido a terceiros sem a autorização prévia da Fresnomaq Indústria de Máquinas S/A

Vista Explodida Carenagem

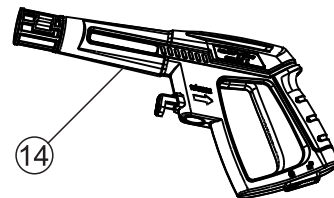
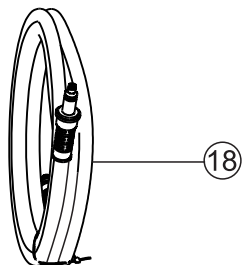
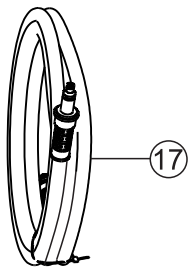
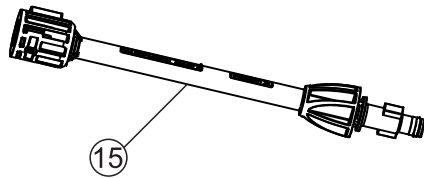
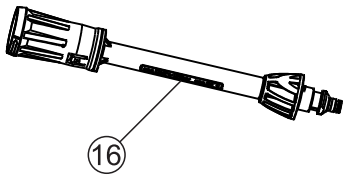
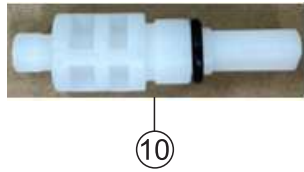
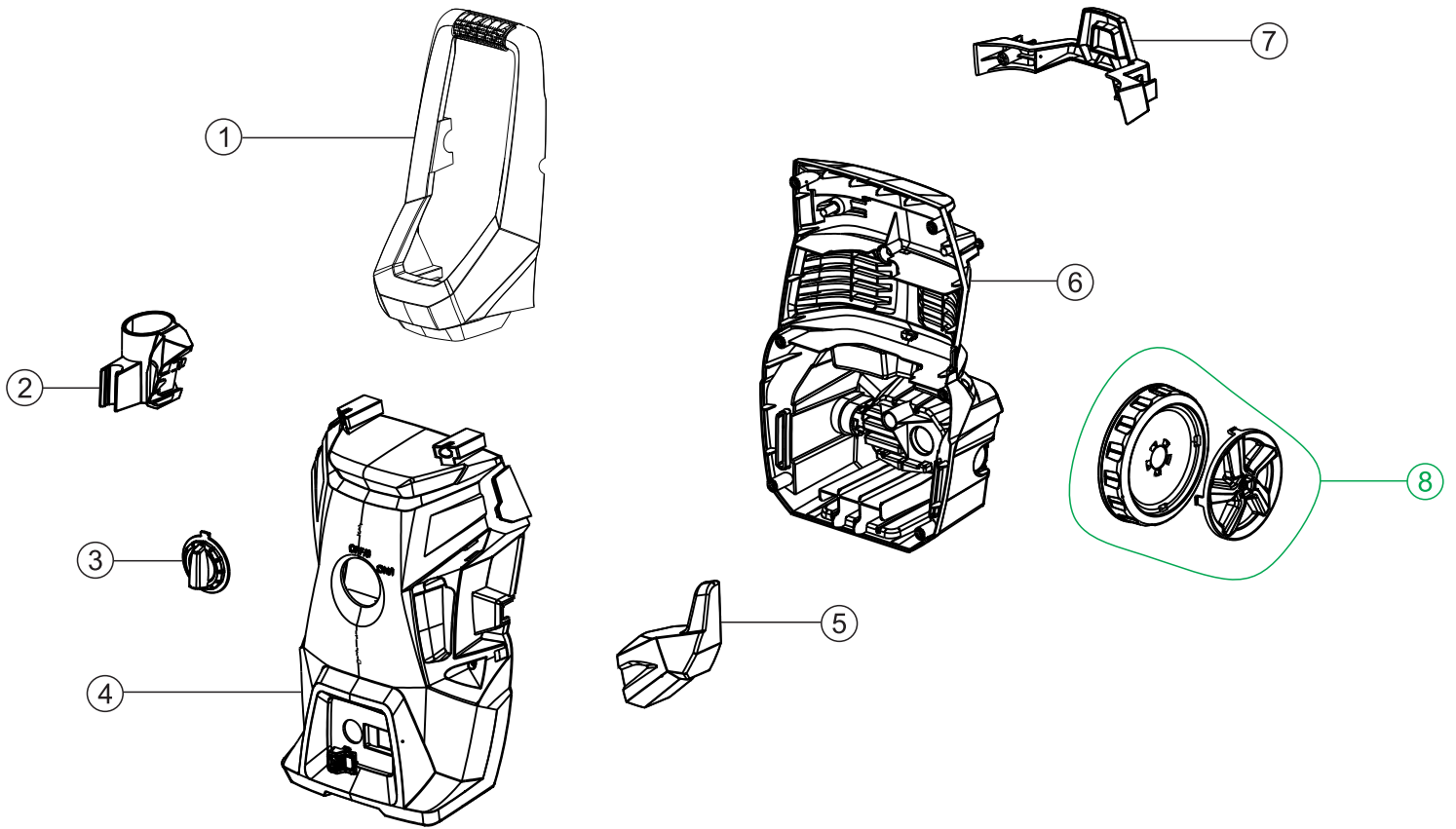

Lista de Peças

| | | | | |
|----|----------|--------------------------|---|---|
| 01 | FW009683 | ALÇA LONGA | 1 |  |
| 02 | FW009653 | SUPORE DA PISTOLA | 1 |  |
| 03 | FW009685 | BOTÃO DO INTERRUPTOR | 1 |  |
| 04 | FW009686 | CARENAGEM FRONTAL | 1 |  |
| 05 | FW009654 | SUPORE P/ CABO ELÉTRICO | 1 |  |
| 06 | FW009684 | CARENAGEM TRASEIRA | 1 |  |
| 07 | FW009673 | PORTA ACESSÓRIOS | 1 |  |
| 08 | FW009690 | KIT RODA E CALOTA | 2 |  |
| 09 | FW009641 | INTERRUPTOR ELÉTRICO | 1 |  |
| 10 | FW009642 | ACIONADOR DO INTERRUPTOR | 1 |  |





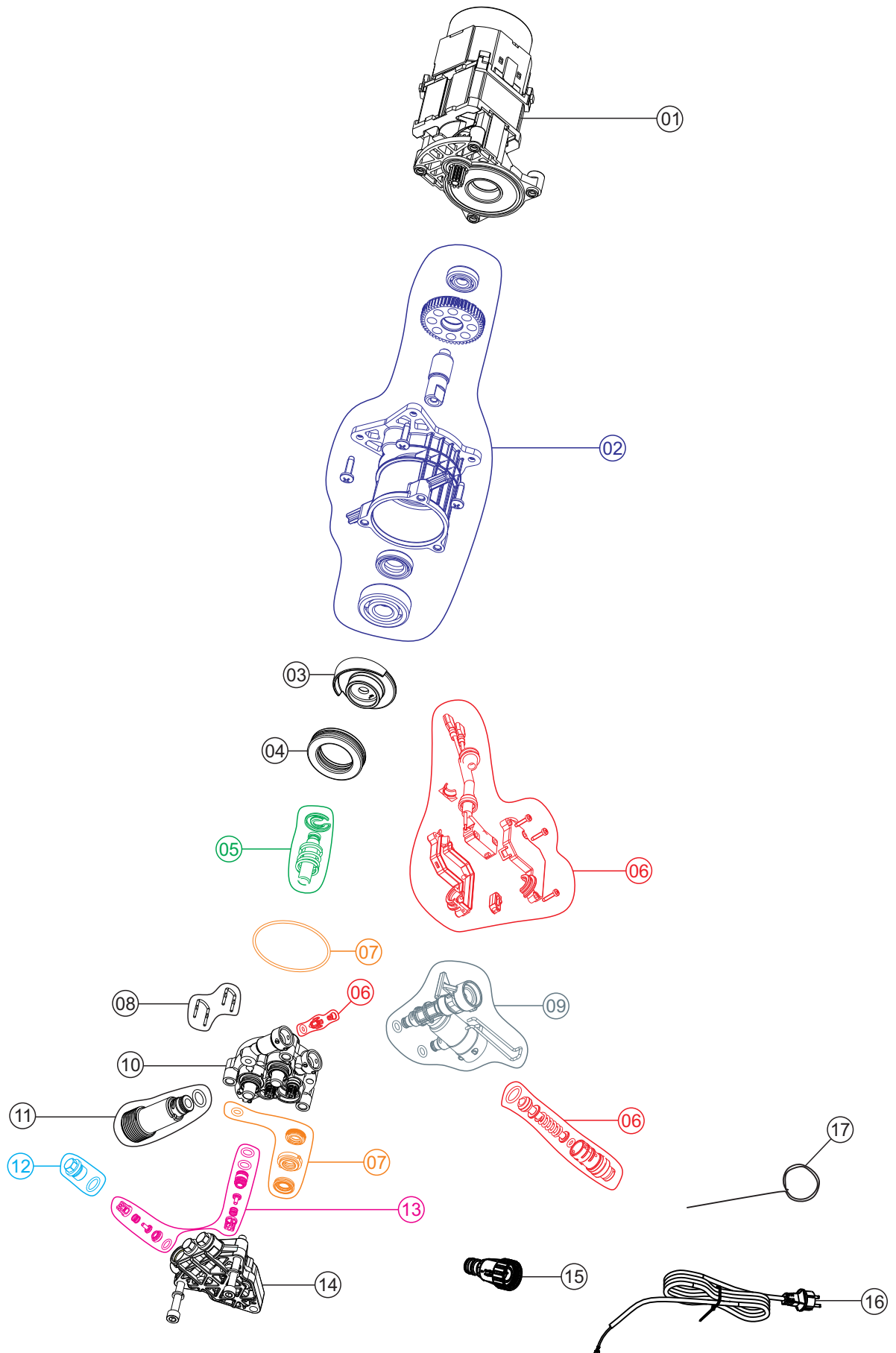

Lista de Peças

| | | | | |
|----|----------|--|---|---|
| 11 | FW009695 | TAMPA DA CAIXA ELÉTRICA | 1 |  |
| 12 | FW009697 | TAMPA SUPERIOR DO MOTOR | 1 |  |
| 13 | FW009696 | TAMPA INFERIOR DO MOTOR | 1 |  |
| 14 | FW009674 | PISTOLA DE ALTA PRESSÃO | 1 |  |
| 15 | FW009692 | BAIONETA | 1 |  |
| 16 | FW009691 | LANÇA C/ BICO REGULÁVEL | 1 |  |
| 17 | FW009672 | MANGUEIRA DE ALTA PRESSÃO NYLON 5 METROS | 1 |  |
| 18 | FW006951 | MANGUEIRA DESENTUPIDORA | 1 |  |
| 19 | FW009693 | APLICADOR DE DETERGENTE | 1 |  |
| 20 | FW009694 | BICO TURBO | 1 |  |







Vista Explodida Conj. Motorbomba



Lista de Peças

| | | | | |
|----|----------|--|---|---|
| 01 | FW009688 | MOTOR ELÉTRICO UNIVERSAL 127V 50/60 HZ | 1 |  |
| | FW009689 | MOTOR ELÉTRICO UNIVERSAL 220V 50/60 HZ | | |
| 02 | FW009666 | KIT CARTER ENGRENAGEM | 1 |  |
| 03 | FW009687 | CAME | 1 |  |
| 04 | FW009650 | ROLAMENTO AXIAL | 1 |  |
| 05 | FW009649 | KIT PISTÃO (C/ 3 UNIDADES) | 1 |  |
| 06 | FW009681 | KIT MICROSWITCH | 1 |  |
| 07 | FW009663 | KIT VEDAÇÃO (C/ 3 UNIDADES) | 1 |  |
| 08 | FW009651 | KIT PINO TRAVA (C/ 4 UNIDADES) | 1 |  |
| 09 | FW009647 | KIT CONEXÃO SAÍDA DE ÁGUA | 1 |  75,9mm |
| 10 | FW009660 | GUIA PISTÃO | 1 |  |

Lista de Peças

| | | | | |
|----|----------|---|---|---|
| 11 | FW009648 | KIT CONEXÃO ENTRADA DE ÁGUA 80mm | 1 |  |
| 12 | FW009652 | KIT TAMPÃO (C/ 3 UNIDADES) | 1 |  |
| 13 | FW009662 | KIT VÁLVULA SUÇÇÃO/ PRESSÃO (C/ 6 UNIDADES) | 1 |  |
| 14 | FW009659 | CABEÇOTE DE ALUMÍNIO | 1 |  |
| 15 | FW006859 | ESPIGÃO ENGATE RÁPIDO CPL | 1 |  |
| 16 | FW009667 | CABO ELÉTRICO 2X1,5mm ² 2 PINO 4,8mm | 1 |  |
| | FW009668 | CABO ELÉTRICO 2X0,75 mm ² 2 PINO 4mm | | |
| 17 | FW006893 | AGULHA LIMPA BICO | 1 |  |
| * | FW009635 | MANUAL DE INSTR WAP WL 2660 TURBO | 1 | - |
| * | Fw009636 | CX WAP WL 2660 TURBO | 1 | - |
| * | ECB00233 | ETIQ C. BAR WAP WL 2660 TURBO 127V | 1 | |
| * | ECB00234 | ETIQ C. BAR WAP WL 2660 TURBO 220V | 1 | |
| * | ECB00235 | ETIQ C. BAR WAP WL 2660 TURBO ULTRA 127V | 1 | |
| * | ECB00236 | ETIQ C. BAR WAP WL 2660 TURBO ULTRA 220V | 1 | |

Lista de Revisões

| N° | DESCRIÇÃO | DATA |
|----|--|------------|
| 00 | Emissão inicial | 14/11/2023 |
| 01 | Atualização na foto ilustrativa do item FW009690 | 04/09/2024 |
| 02 | Ajuste na descrição do item FW009648 | 17/10/2024 |
| 03 | Adicionado o item FW006893 | 08/01/2025 |
| 04 | Substituição do item FW009682 para FW009647 | 11/03/2025 |
| 05 | Correção da descrição do item FW009667 | 22/05/2025 |
| | | |
| | | |
| | | |



Fresnomaq Indústria de Máquinas S/A
Tel.: (41) 3513-9600 - Fax: (41) 3513-9630
Rua Antônio Singer, 200 - São José dos Pinhais, PR, Brasil
www.wap.ind.br - wap@wap.ind.br