

# Wap

## CATÁLOGO DE PEÇAS PARA REPOSIÇÃO



## LAVADORA DE ALTA PRESSÃO WAP PREMIUM 2600 / PREMIUM 2600 ULTRA

31020011 (127V)  
31020022 (220V)

ULTRA - FW007650 (127V)  
ULTRA - FW007651 (220V)

REVISÃO : 04 NOVEMBRO/2024  
REFERÊNCIA - VEG02.059

O conteúdo deste documento não deve ser reproduzido ou cedido a terceiros sem a autorização prévia da Fresnomaq Indústria de Máquinas S/A



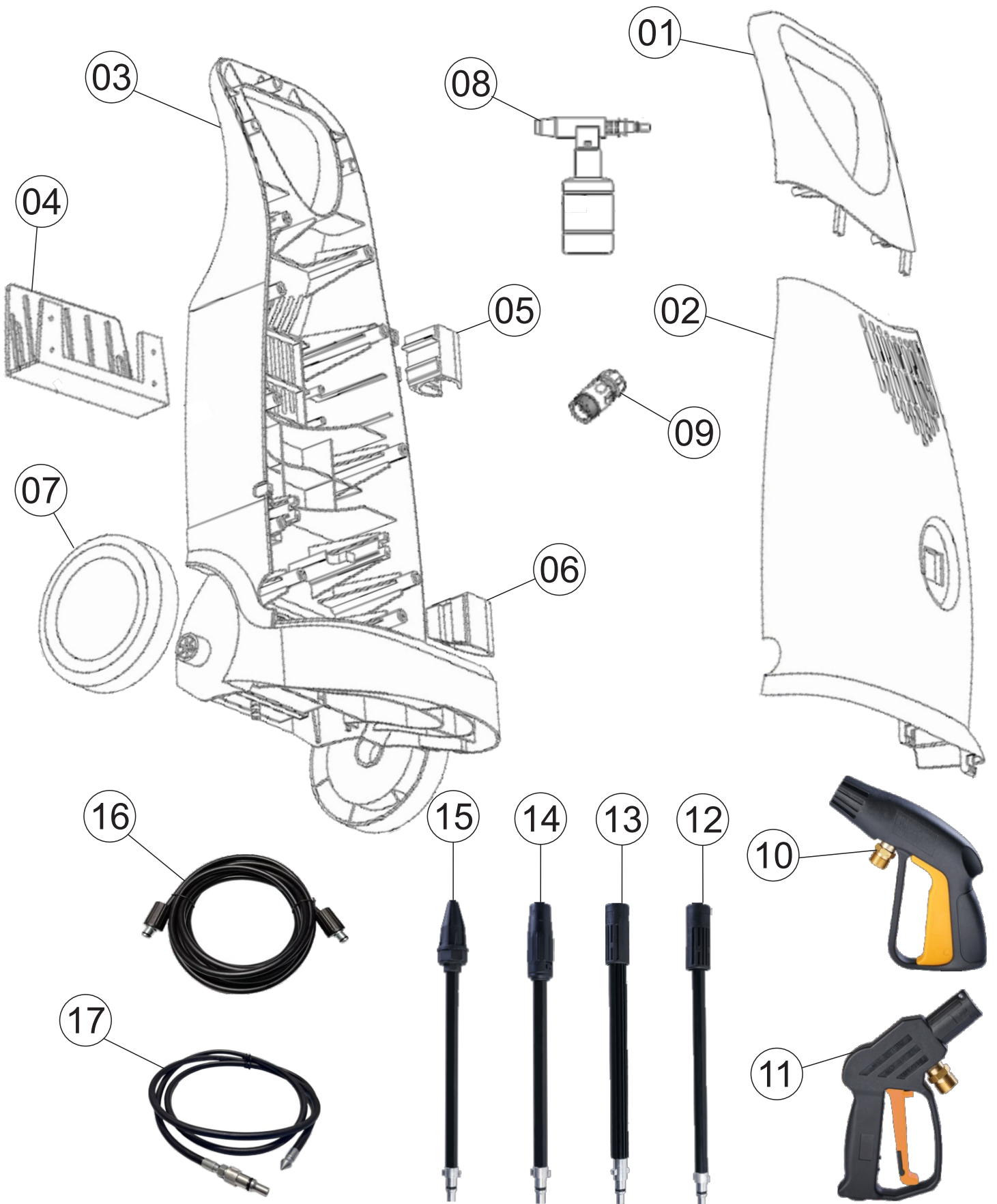



# Vista Explodida Carenagem



# Lista de Peças

01	120EP-049	ALÇA	1	
02	120EP-056	CARENAGEM SUPERIOR	1	
03	120EP-058	CARENAGEM INFERIOR	1	
04	120EP-059	SUPORE ACESSÓRIOS	1	
05	120EP-035	SUPORE LANÇA SUP	1	
06	120EP-034	SUPORE LANÇA INF	1	
07	120EP-057	RODA PRETA C/ CALOTA	2	
08	VB70-0058	RESERVATÓRIO SHAMPOO ENCAIXE LARGO	1	
	120EP-060	APLICADOR DE DETERGENTE ENCAIXE FINO		
09	VB70-0059	ENGATE RÁPIDO	1	
10	VB70-0075	PISTOLA M-22 ENCAIXE LARGO	1	

# Lista de Peças

11	20011207	PISTOLA M-22 ENCAIXE FINO «TODAS»	1	
12	20011208	BAIONETA ALUMINIO ENCAIXE FINO «TODAS»	1	
13	120EP-068	BAIONETA ALUMINIO ENCAIXE LARGO «TODAS»	1	
14	120EP-067	LANÇA VARIO 120BAR ALUMÍNIO E PLÁSTICO	1	
15	120EP-065	LANÇA BICO TURBO	1	
16	70015005	MANG AP 1/4 M22XM22 TRA DE AÇO 5,5M	1	
17	FW006948	MANGUEIRA DESENTUPIDORA (EXCLUSIVO LINHA ULTRA)	1	
*	31020001	CX WAP PREMIUM 2600	1	*
*	70050482	ETIQ C. BAR WAP PREMIUM 2600 127V	1	*
*	70050483	ETIQ C. BAR WAP PREMIUM 2600 220V	1	*
*	ECB00114	ETIQ C. BAR WAP DESOBSTRUIDORA PREMIUM ULTRA 2600 127V	1	*
*	ECB00115	ETIQ C. BAR WAP DESOBSTRUIDORA PREMIUM ULTRA 2600 220V	1	*
*	99071019	MANUAL DE INSTR WAP PREMIUM 2600	1	*
*	FW008095	MANUAL DE INSTR WAP PREMIUM 2600 ULTRA	1	*

# Vista Explodida Conj. Motorbomba

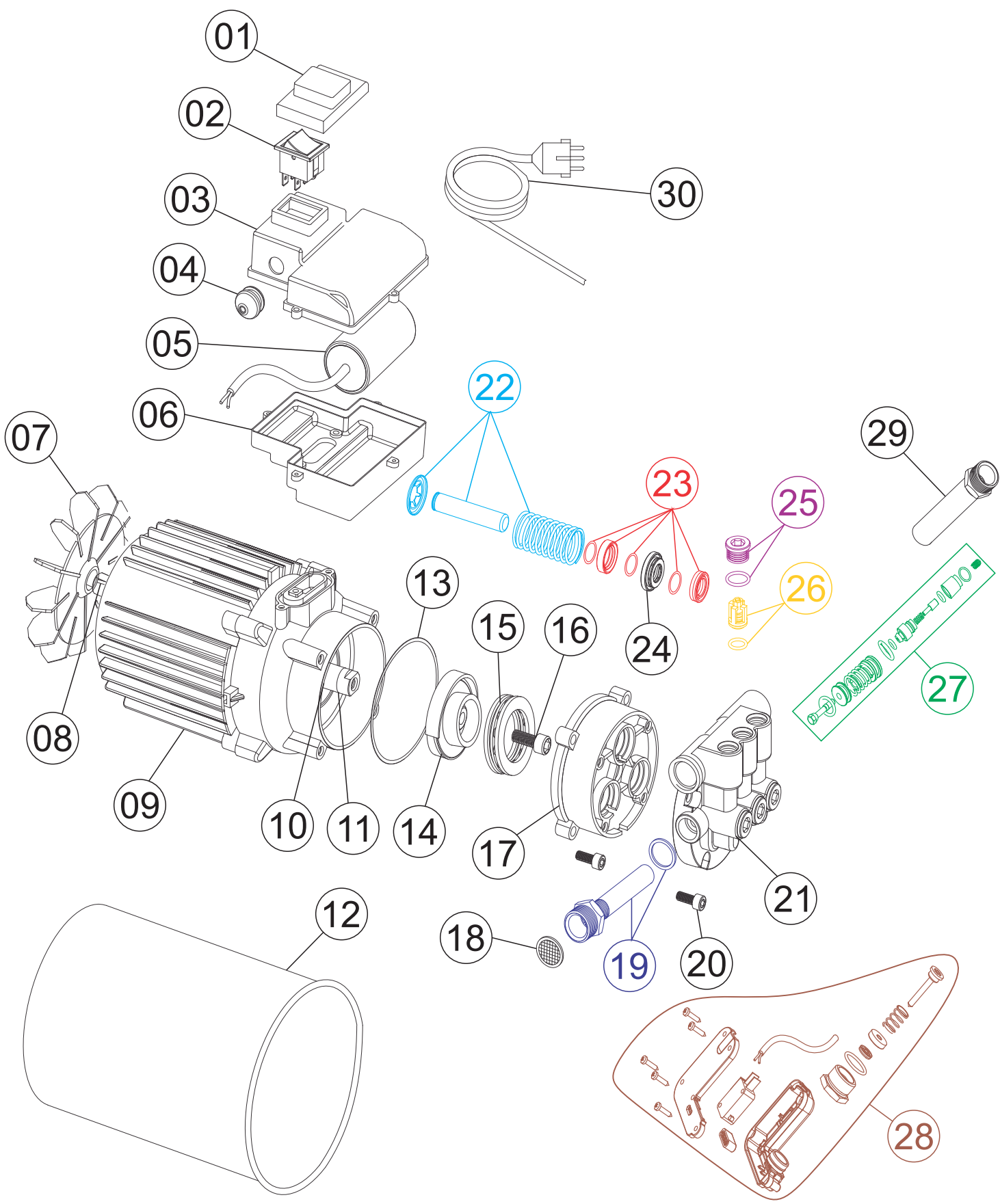

# Lista de Peças

01	VB70-0053	PROTETOR INTERRUPTOR	1	
02	VB70-0052	INTERRUPTOR ELÉTRICO	1	
03	120EP-053	TAMPA SUP CAPACITOR	1	
04	120EP-052	PASSA CABO	1	
05	120EP-051	CAPACITOR 90uF 127V (Preto)	1	
	120EP-51A	CAPACITOR 30uF 220V (Branco)		
06	120EP-050	SUORTE CAPAC	1	
07	APW90-77	VENTOINHA DO MOTOR	1	
08	74011280	ROLAMENTO TRASEIRO DO MOTOR (6202)	1	
09	120EP-033	MOTOR WAP PREMIUM II 127V/60Hz	1	
	120EP-33A	MOTOR WAP PREMIUM II 220V/60Hz		
10	19524000	ROLAMENTO DIANTEIRO DO MOTOR (6302)	1	

# Lista de Peças

11	41031000	RETENTOR 18 X 28 X 7	1	
12	120EP-036	PROTETOR DO MOTOR	1	
13	VB70-0032	O'RING VEDAÇÃO CARTER	1	
14	VA90-0031	CAME DE ALUMÍNIO 6,2° - 127V	1	
	VA90-0032	CAME DE ALUMÍNIO 6,8° - 220V		
15	VB70-0030	ROLAMENTO ESFERA	1	
16	VB70-0029	PARAFUSO CAME M8X20	1	
17	120EP-028	GUIA PISTÕES	1	
18	VB70-0018	FILTRO PENEIRA ENTRADA ÁGUA	1	
19	120EP-16-17	KIT N° 02 ENTR ÁGUA DA BOMBA HIDROLAVADORA	1	
20	21471062	PARAF ALLEN CC M8 X 20 ZN	1	



# Lista de Peças

21	120EP-014	CABEÇOTE	1	
22	VB70-49-51	KIT N° 07 PISTÕES (C/ 3 UNID.)	1	
23	VB70-44-48	KIT N° 06 VEDAÇÕES DE BORACHA	1	
24	VB70-0040	ANEL CENTRALIZADOR	1	
25	VA90-42-43	KIT N° 05 TAMP VALV+ORING C/6	1	
26	VA90-40-41	KIT N° 04 VALV+ORING S/P C/6	1	
27	120EP-0313	KIT N° 01 VALV BY PASS + VALV RETENÇÃO	1	
28	VB70-19-27	KIT N° 03 CONJ MICRO SWITCH	1	
29	120EP-0001	CONEXÃO SAÍDA AGUA	1	
30	VH130P-64	CABO ELÉTRICO 3x2,5mm 5 METROS PINO 4,8mm	1	



# Lista de Revisões

N°	DESCRIÇÃO	DATA
00	Correção da imagem do item VB70-44-48	01/01/2019
01	Inclusão do código VA90-0032	25/06/2020
02	Inclusão do código FW006948 (linha ultra)	04/08/2021
03	Atualização da estrutura da vista	12/11/2024



Fresnomaq Indústria de Máquinas S/A  
Tel.: (41) 3513-9600 - Fax: (41) 3513-9630  
Rua Antônio Singer, 200 - São José dos Pinhais, PR, Brasil  
[www.wap.ind.br](http://www.wap.ind.br) - [wap@wap.ind.br](mailto:wap@wap.ind.br)