

Wap

CATÁLOGO DE PEÇAS PARA REPOSIÇÃO



LAVADORA DE ALTA PRESSÃO WAP COMBATE TURBO 2600 WAP COMBATE TURBO ULTRA 2600

FW006751 (127V)
FW006752 (220V)

ULTRA - FW007676 (127V)
ULTRA - FW007677 (220V)

REVISÃO : 05 DEZEMBRO/2024
REFERÊNCIA - VEG02.072

O conteúdo deste documento não deve ser reproduzido ou cedido a terceiros sem a autorização prévia da Fresnomaq Indústria de Máquinas S/A

Vista Explodida Carenagem

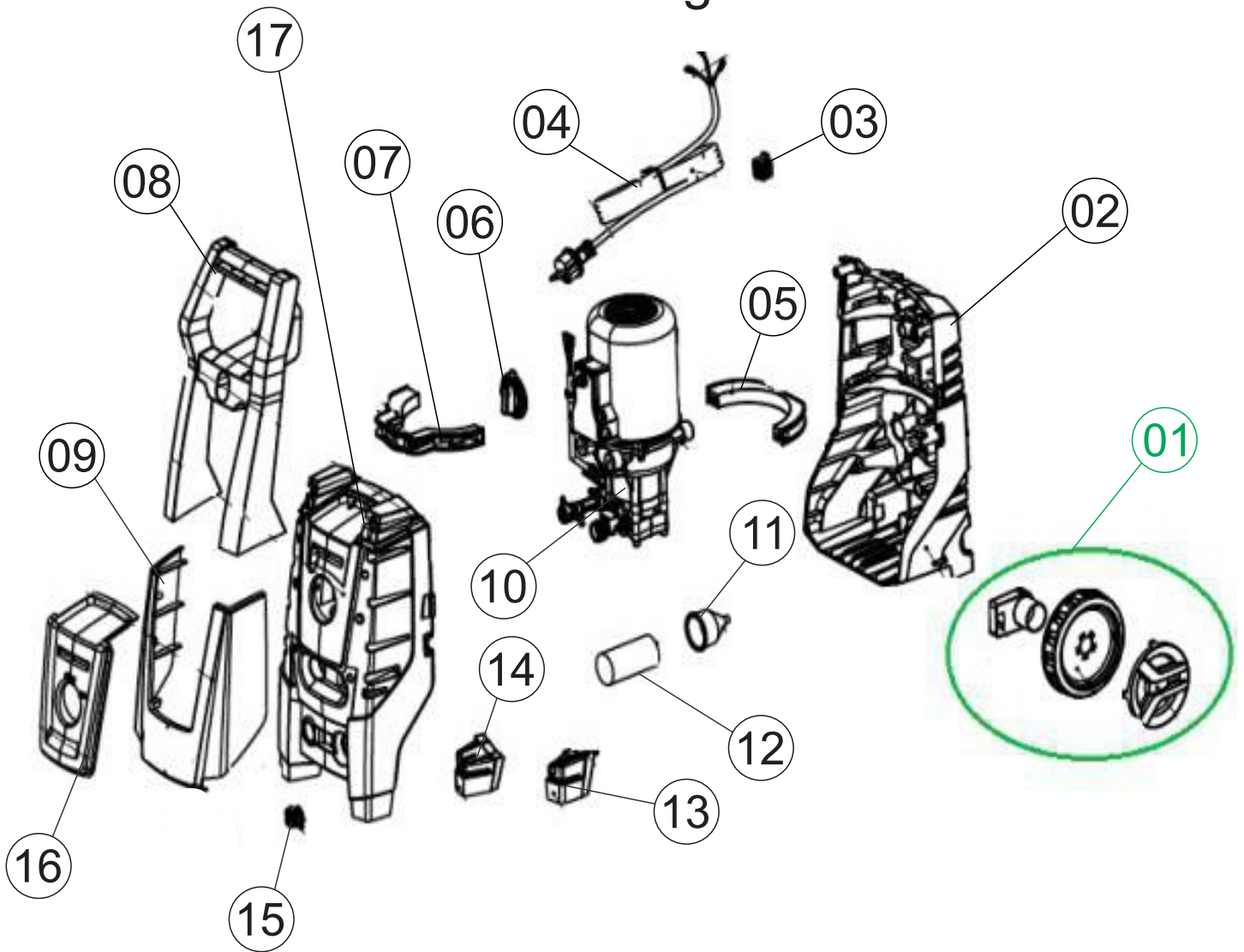

Acessórios

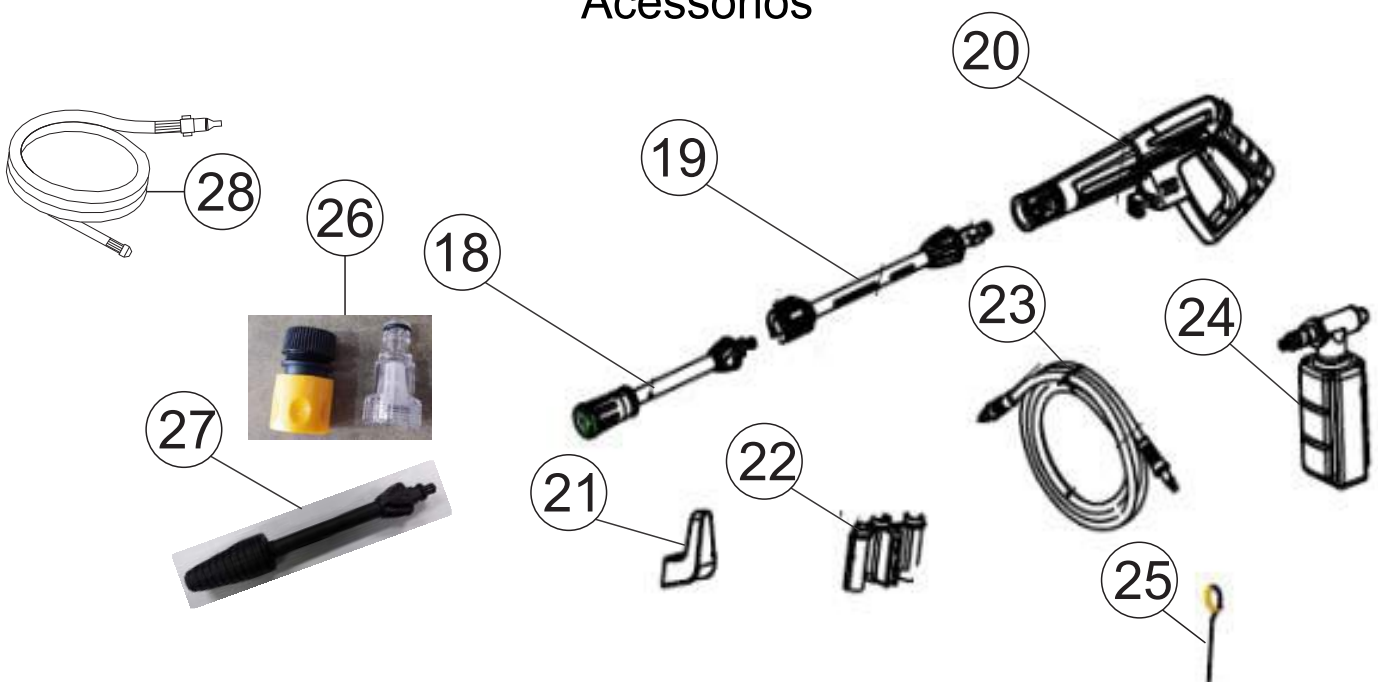

Lista de Peças

01	FW006853	KIT EIXO/RODA E CALOTA	1	
02	FW006836	CARENAGEM TRASEIRA	1	
03	FW006839	PRENSA CABO	1	
04	FW006837	CABO ELÉTRICO 3x1,5 mm PINO 4,8mm (127V)	1	
	FW006838	CABO ELÉTRICO 3x1 mm PINO 4mm (220V)		
05	FW006842	ANEL DE ENCOSTO INFERIOR DO MOTOR	1	
06	FW006848	BOTÃO INTERRUPTOR	1	
07	FW006841	ANEL DE ENCOSTO SUPERIOR DO MOTOR	1	
08	FW006845	ALÇA LONGA	1	
09	FW006846	ESPELHO CARENAGEM FRONTAL	1	
10	FW006843	CONJUNTO MOTOBOMBA 127V	1	
	FW006844	CONJUNTO MOTOBOMBA 220V		

Lista de Peças

11	FW006862	CAPA PROTEÇÃO DO CAPACITOR	1	
12	FW006860	CAPACITOR 100uF 127V (250VCA)	1	
	FW006861	CAPACITOR 30uF 220V (450VCA)		
13	FW006852	APOIO INFERIOR DIREITO	1	
14	FW006851	APOIO INFERIOR ESQUERDO	1	
15	FW006850	BOTÃO TRAVA MANGUEIRA	1	
16	FW006847	ESPELHO BOTÃO LIGA/DESLIGA	1	
17	FW006849	CARENAGEM FRONTAL	1	
18	FW006857	LANÇA COM BICO REGULÁVEL	1	
19	FW006856	BAIONETA	1	
20	FW006855	PISTOLA DE ALTA PRESSÃO	1	





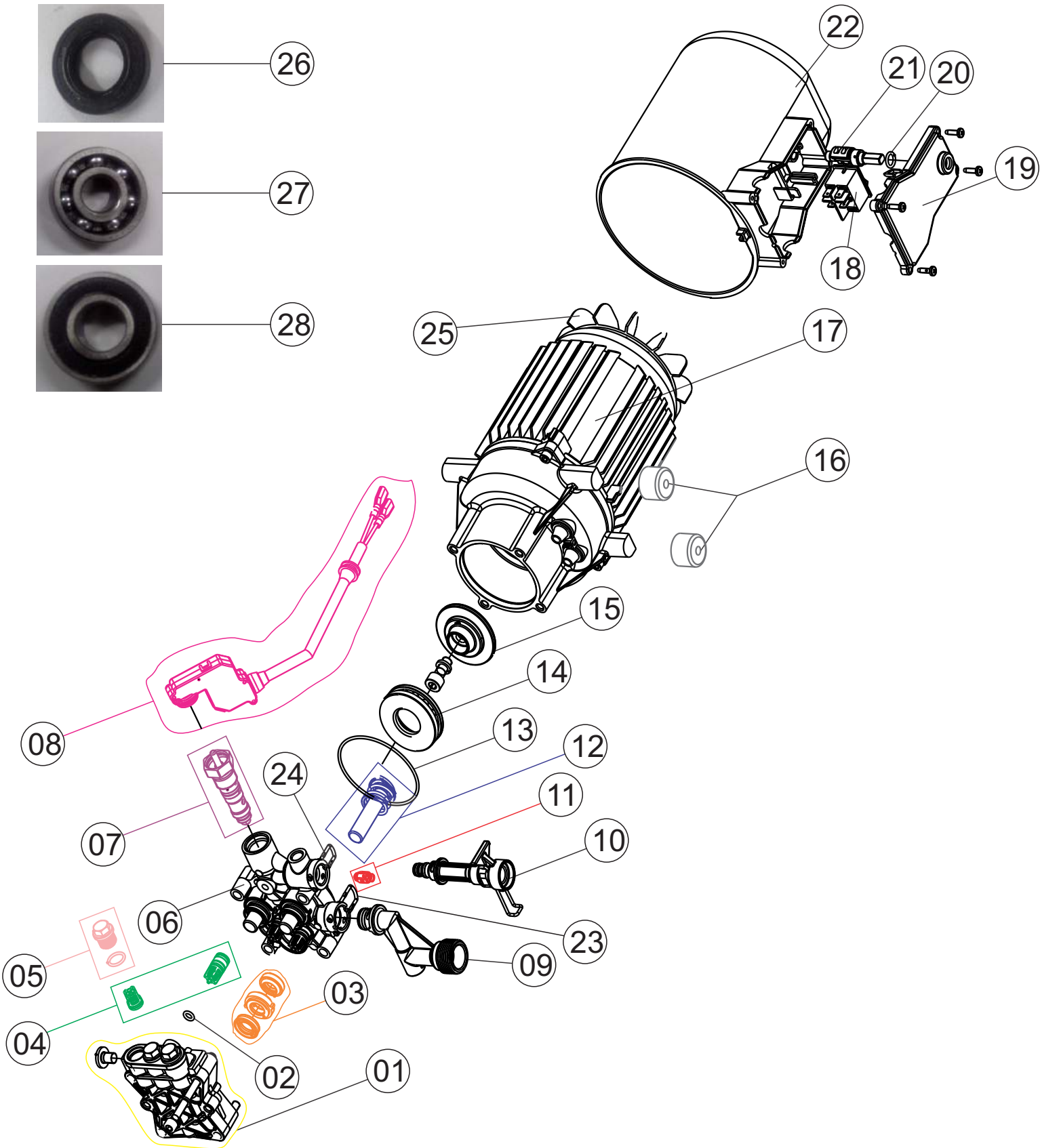

Lista de Peças

21	FW006840	SUPORE PARA CABO ELÉTRICO	1	
22	FW006835	PORTA ACESSÓRIOS	1	
23	FW006854	MANGUEIRA AP COM TRAMA DE NYLON (5 METROS)	1	
24	FW006858	APLICADOR DE DETERGENTE	1	
25	FW006893	AGULHA LIMPA BICO	1	
26	FW006859	KIT ENGATE RÁPIDO DE ACRÍLICO - CPL	1	
27	FW006894	LANÇA BICO TURBO	1	
28	FW006951	MANGUEIRA DESENTUPIDORA (EXCLUSIVO LINHA ULTRA)	1	

Vista Explodida Conj. Motorbomba









Lista de Peças

01	FW006883	CABEÇOTE DE ALUMÍNIO	1	
02	FW006882	O-RING 5,5x2mm	1	
03	FW006886	KIT VEDAÇÃO (C/3 UNIDADES)	1	
04	FW006885	KIT VÁLVULA DE SUÇÃO E PRESSÃO (C/6 UNIDADES)	1	
05	FW006881	KIT TAMPÃO (C/3 UNIDADES)	1	
06	FW006884	GUIA PISTÕES	1	
07	FW006873	KIT BY-PASS	1	
08	FW006868	KIT MICROSWITCH	1	
09	FW006872	KIT CONEXÃO ENTRADA DE ÁGUA	1	
10	FW006870	KIT CONEXÃO SAÍDA DE ÁGUA	1	

Lista de Peças

11	FW006871	KIT VÁLVULA DE RETENÇÃO + O-RING 3,5x1,9mm	1	
12	FW006876	KIT PISTÕES (C/3 UNIDADES)	1	
13	FW006878	O-RING VEDAÇÃO DO MOTOR (66x2mm)	1	
14	FW006877	ROLAMENTO AXIAL	1	
15	FW006879	CAME 8°	1	
16	FW006869	SAPATA DO MOTOR	4	
17	FW006887	MOTOR ELÉTRICO DE INDUÇÃO 127V	1	
	FW006888	MOTOR ELÉTRICO DE INDUÇÃO 220V		
18	FW006863	INTERRUPTOR ELÉTRICO	1	
19	FW006866	TAMPA DA CAIXA ELÉTRICA	1	
20	FW006865	O-RING VEDAÇÃO DA CAIXA ELÉTRICA (8x2mm)	1	

Lista de Peças

21	FW006864	ACIONADOR DO INTERRUPTOR	1	
22	FW006867	PROTECTOR DO MOTOR	1	
23	FW006875	PINO TRAVA CONEXÃO ENTRADA DE ÁGUA	1	
24	FW006874	PINO TRAVA DA CONEXÃO SAÍDA DE ÁGUA	1	
25	FW006889	VENTOINHA DO MOTOR	1	
26	FW006890	RETENTOR DO MOTOR (20x35x7mm)	1	
27	FW006891	ROLAMENTO FRONTAL DO MOTOR (6303/P53)	1	
28	FW006892	ROLAMENTO TRASEIRO DO MOTOR (6202-RZ)	1	
*	FW006753	CX WAP COMBATE TURBO 2600	1	*
*	FW006754	MANUAL DE INSTR WAP COMBATE TURBO 2600	1	*
*	FW008108	MANUAL DE INSTR WAP COMBATE TURBO 2600 ULTRA	1	*
*	ECB00028	ETIQ C. BAR WAP COMBATE 127V	1	*
*	ECB00029	ETIQ C. BAR WAP COMBATE 220V	1	*
*	ECB00077	ETIQ C. BAR DESOBSTRUIDORA COMBATE TURBO ULTRA 127V	1	*
*	ECB00078	ETIQ C. BAR WAP DESOBSTRUIDORA COMBATE TURBO ULTRA 220V	1	*

Lista de Revisões

N°	DESCRIÇÃO	DATA
00	Emissão Inicial	08/07/2019
01	Atualização descrição dos itens FW006860 e FW006861	09/01/2020
02	Atualização da descrição do item Fw006859	25/03/2020
03	Inclusão do código FW006951 (linha ultra)	04/08/2021
04	Ajuste na descrição do item FW006860	30/09/2024
05	Atualização estrutura da vista explodida	28/11/2024



Fresnomaq Indústria de Máquinas S/A
Tel.: (41) 3513-9600 - Fax: (41) 3513-9630
Rua Antônio Singer, 200 - São José dos Pinhais, PR, Brasil
www.wap.ind.br - wap@wap.ind.br